

Article number: 12621000160710

Description: Threaded pin 621 000 160.710
For M16

Measures

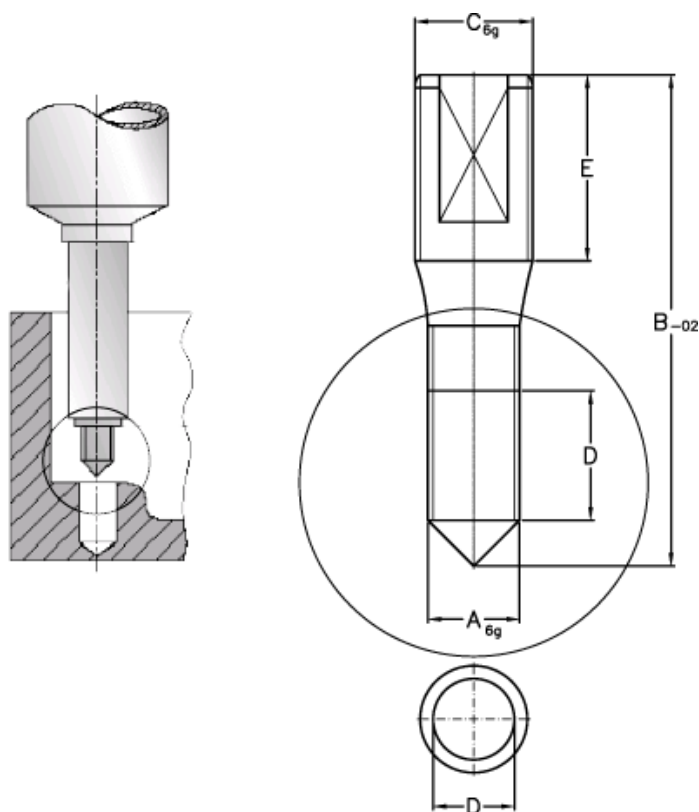

A = M16
B = 144.0
C = M18
D = 36.0
E = 28